



Virtual Private Networks (VPNs) Simplified



Erich Spengler

CSSIA CATC—Moraine Valley Community College

2008—60 Minute Session

Cisco | Networking Academy®
Mind Wide Open™

Agenda

- Demonstration
- Introduction to VPNs
- VPN Security (IPSec, PPTP, SSL)
- VPN Technology Comparison
- VPN Group Exercise

Demonstration—Remote Network Access via VPN

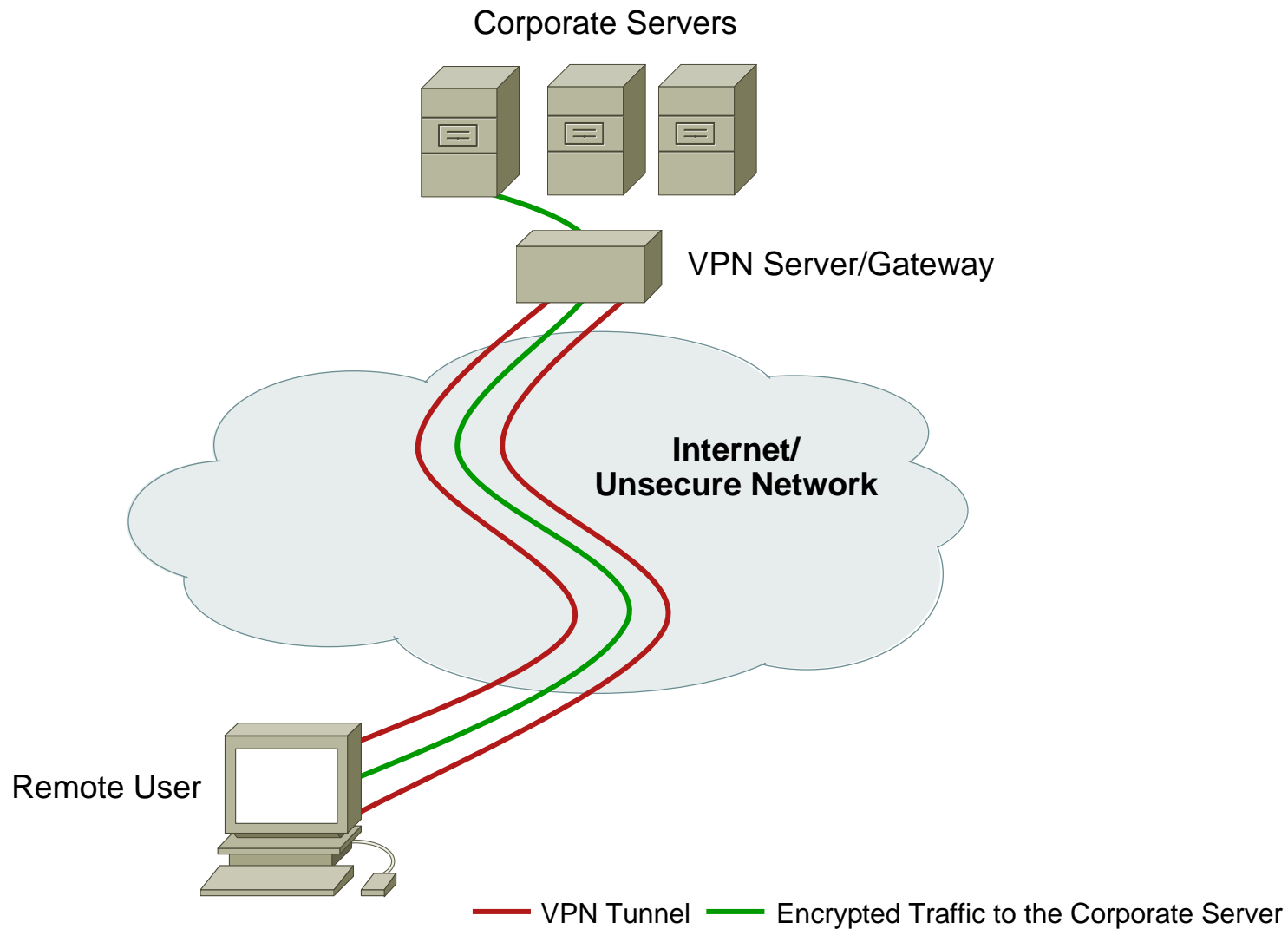

Introduction to VPNs



What Is a Virtual Private Network (VPN)?

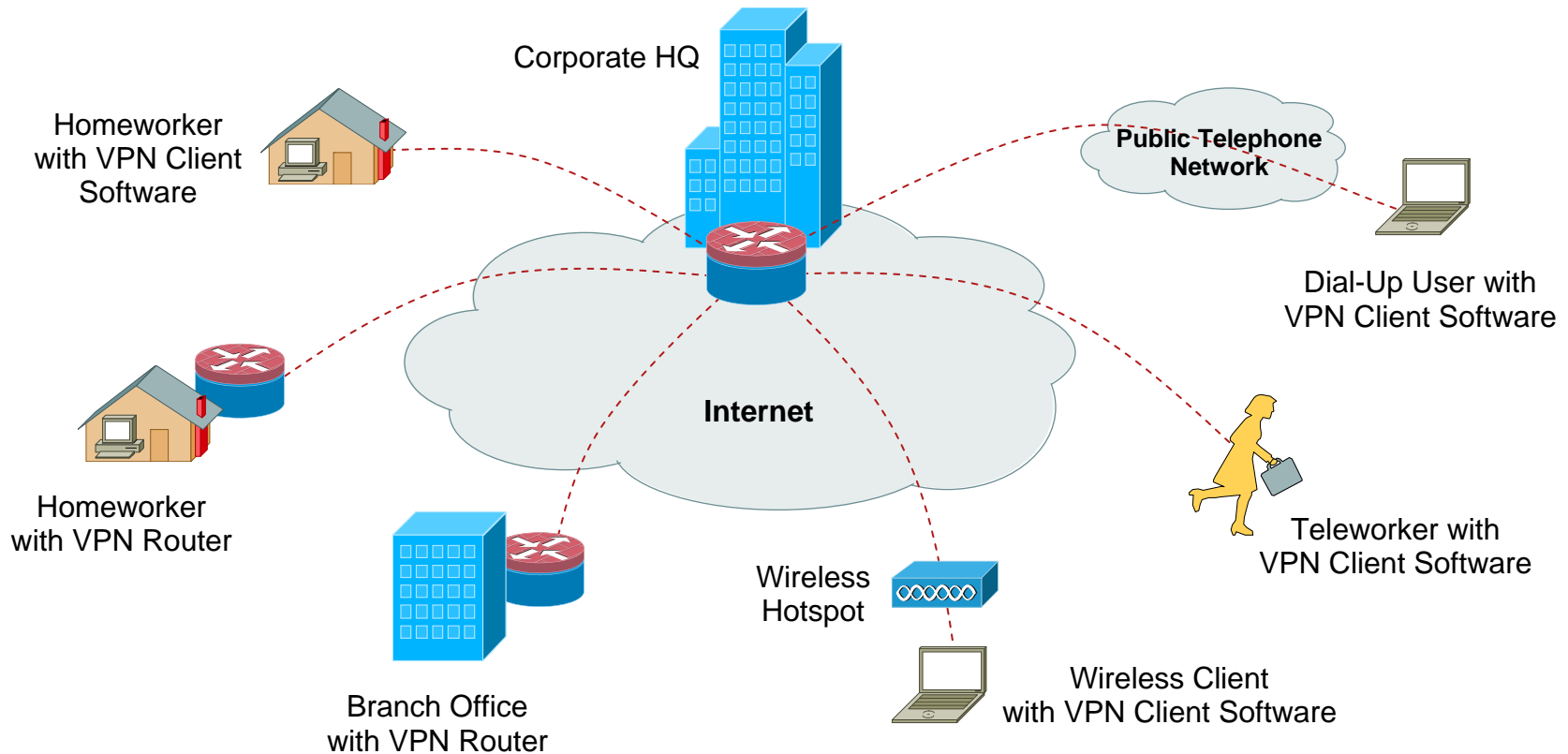

A Remote Access VPN secures connections for remote users, such as mobile users or telecommuters, to corporate LANs over shared service provider networks

Wireless: A New Big Driver for VPNs

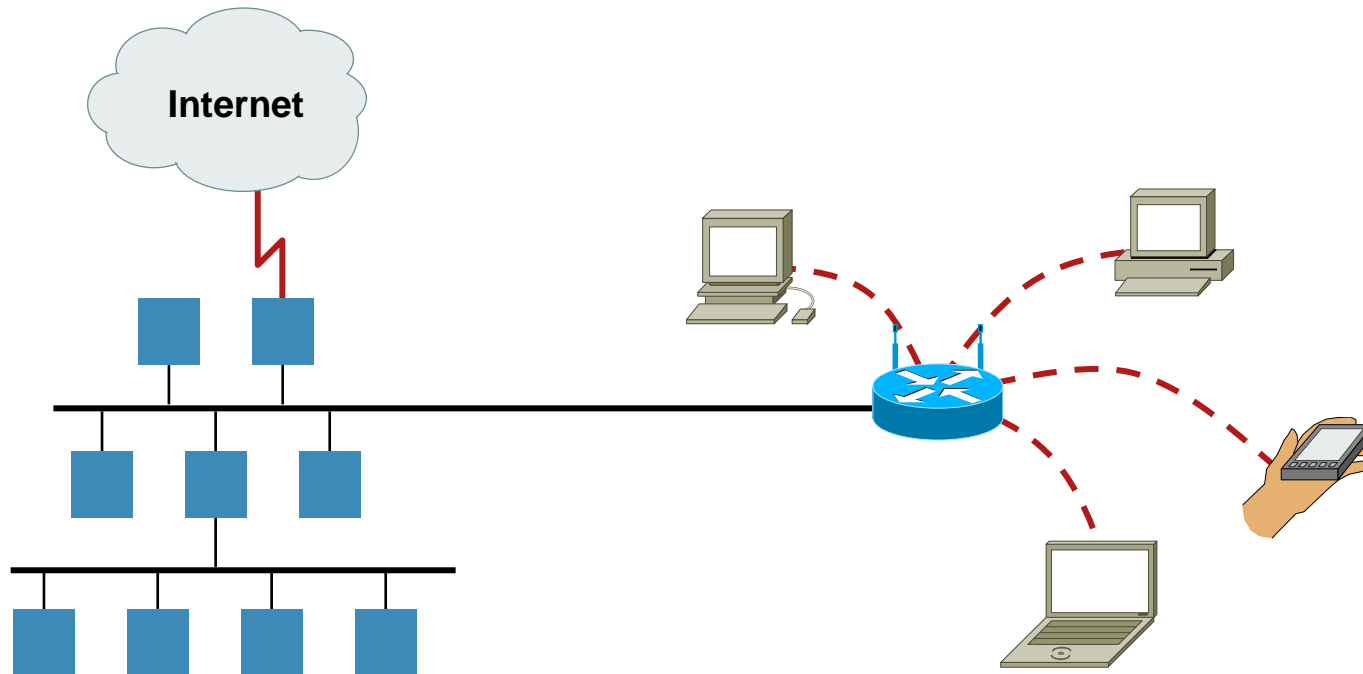

- An access point (AP) is a shared device
- Remember the performance issues of shared hubs
- Bridges, and other devices allow for interconnection
- Protocols and applications work seamlessly

Basic VPN Terms



Router to Router VPN Gateway
(Extranet)



Router to VPN Firewall Gateway
(Extranet)

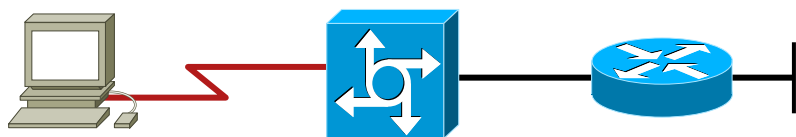

VPN Client to Router VPN via Dial-Up
(Access VPN)

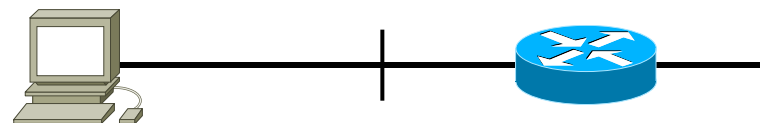

VPN Client to Router VPN Network
(Intranet)



Other Vendors to Router VPN
(Extranet)



Using Site-to-Site VPNs

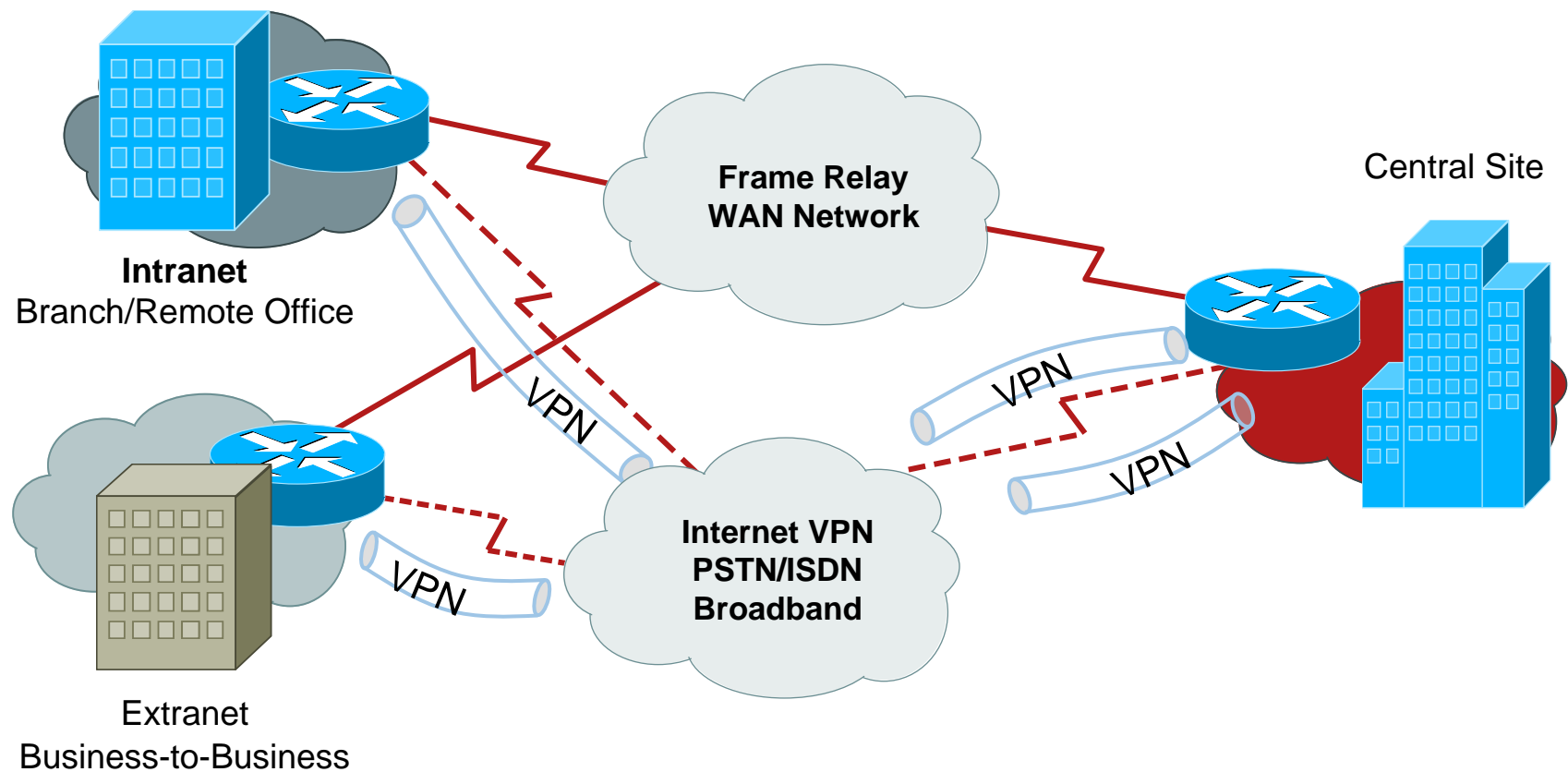

Using Remote-Access VPNs

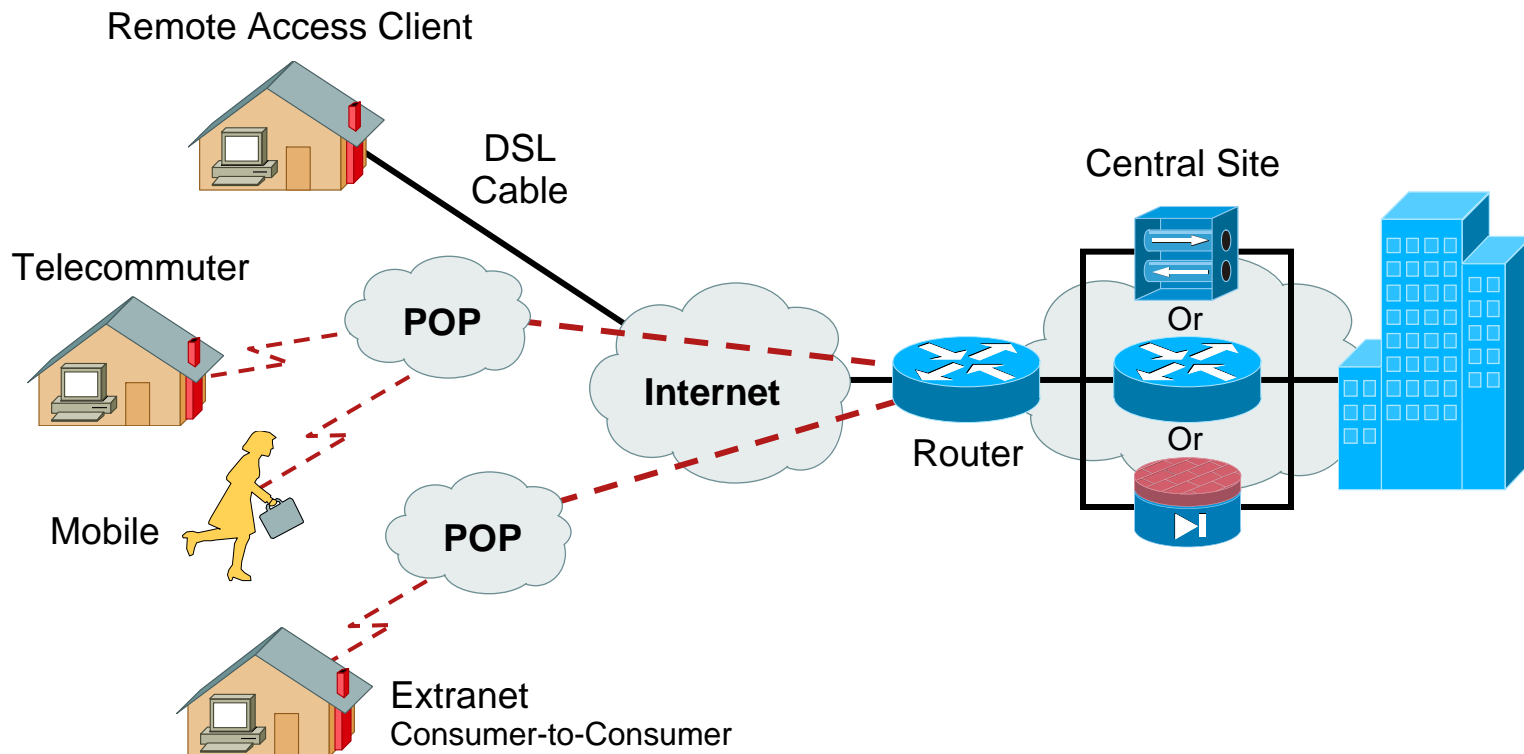

Remote Access Client

- Cisco VPN Clients (IPSec)
- Microsoft Win 9x/NT/2000/XP (LTPPP)
- Thire-party VPN client (PPTP)

Remote Access Gateway

- Cisco WAN Router
- Cisco Secure PIX Firewall
- Or IPSec or PPTP aware device to provide firewall/VPN Tunnel Termination

VPN Components

Separate Data Tunneling

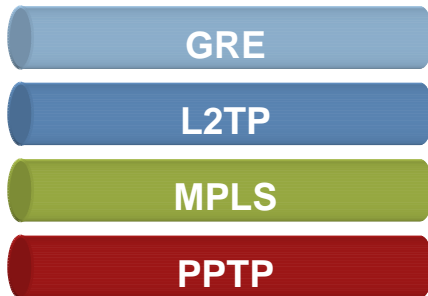

Increase Protection Encryption



Prevent Tampering Integrity

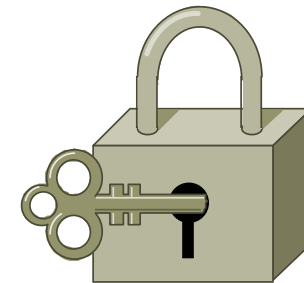

TCP Checksum
AH in IPSec

Identify Source Authentication

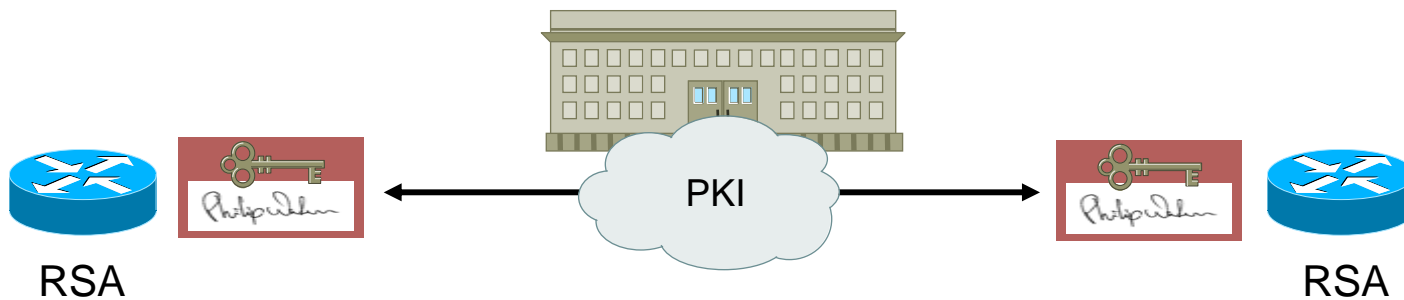

VPN Security

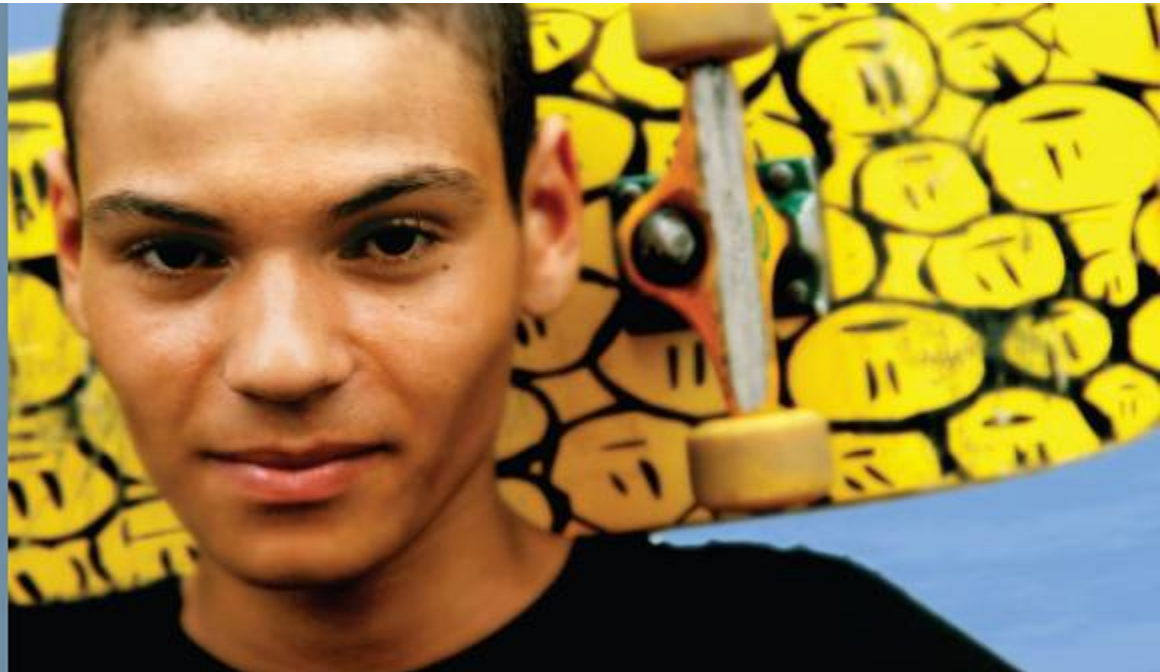

What a VPN Must Provide

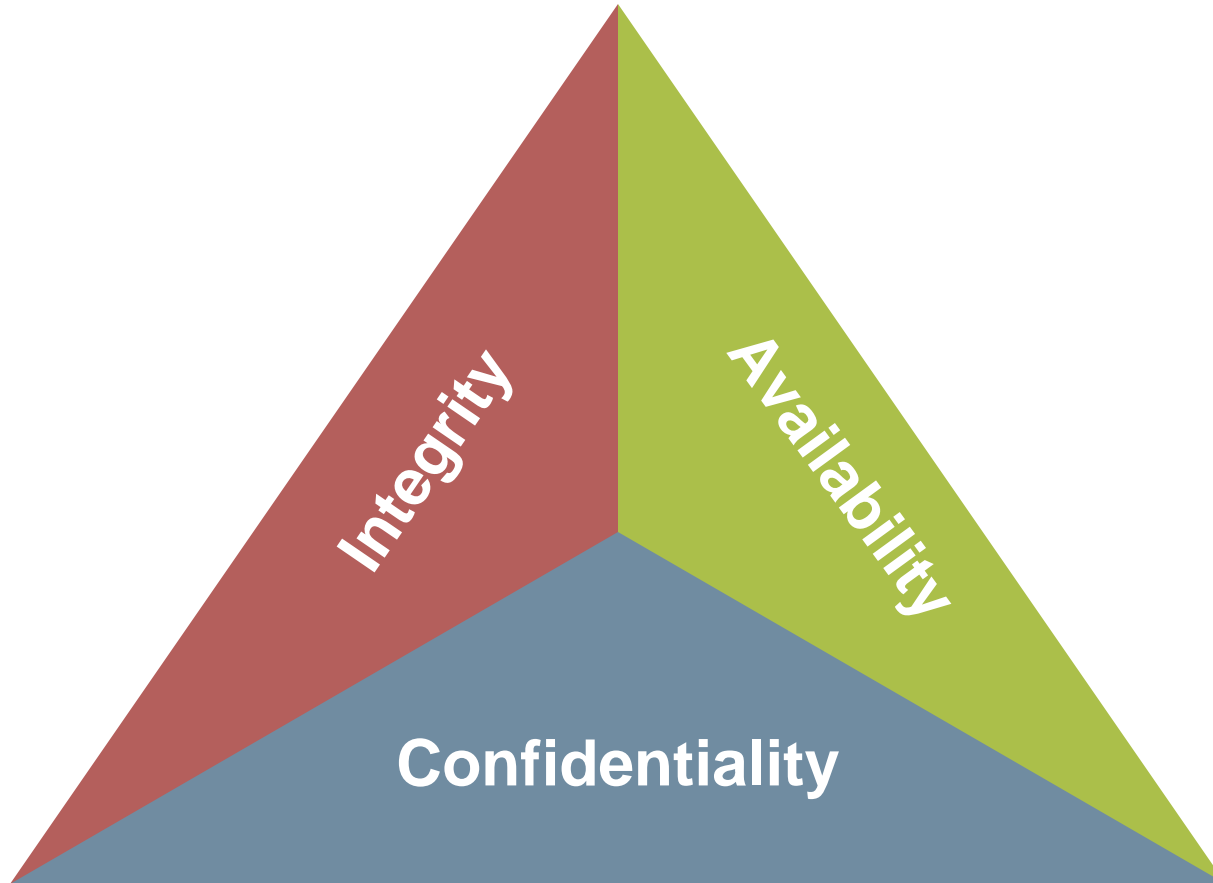



Network Security Model

Data Security Assurance Model (CIA)

Confidentiality

- Benefit
- Ensures data privacy
- Shuns
 - Sniffing
 - Replay

Integrity

- Benefit
 - Ensures data is unaltered during transit
- Shuns
 - Alteration
 - Replay

Authentication

- Benefit
 - Ensures identity of originator or recipient of data
- Shuns
 - Impersonation
 - Replay

Data Confidentiality and Data Integrity Depend on Encryption and Encapsulation

VPN Technology Options

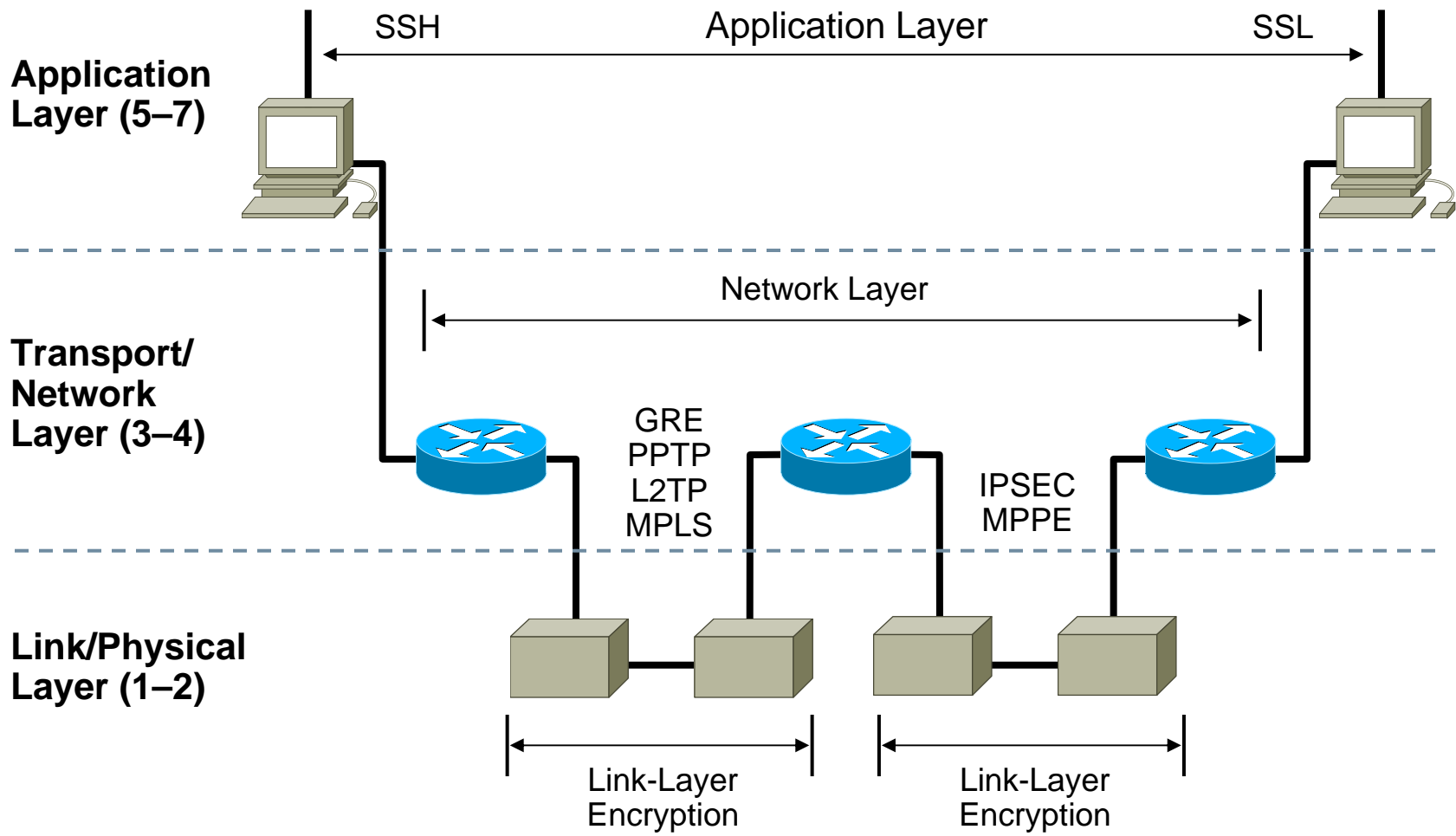

What Is an IPSec VPN?

Internet Protocol Security

- A set of security protocols and algorithms used to **secure IP data at the network layer**
- IPSec provides data **confidentiality** (**encryption**), **integrity** (**hash**), **authentication** (**signature/certificates**) of IP packets while maintaining the ability to route them through existing IP networks

Advantages of IPSec

- Access VPNs
- Classic site-to-site managed VPNs
- Trusted MPLS VPNs

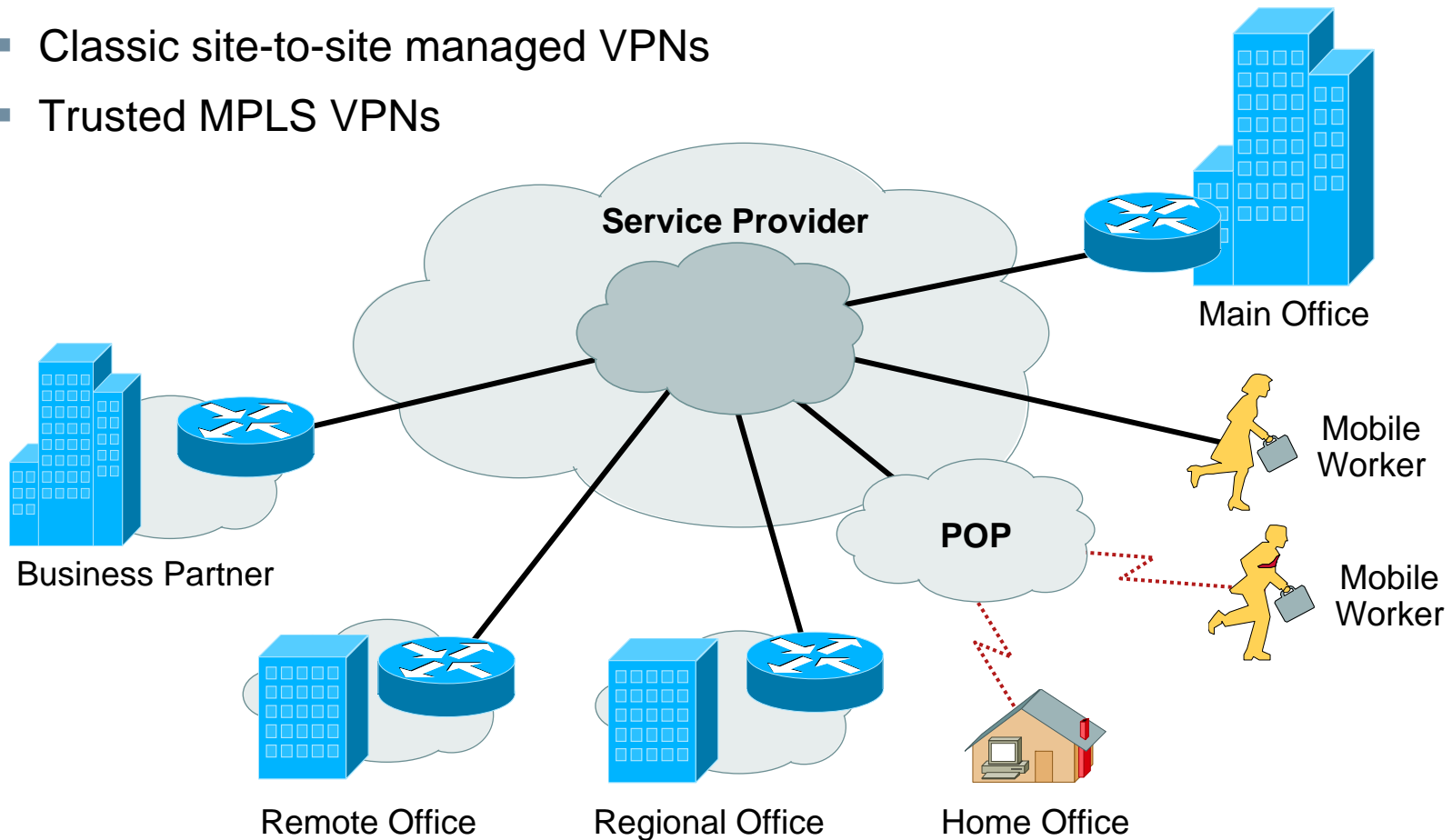



IPSec Key Points

- IPSec can ensure the confidentiality and/or the authenticity of IP packets
- The key points are
 - Two modes of propagation (transport and tunnel)
 - Security associations (SAs)
 - Two types of header (ESP and AH)

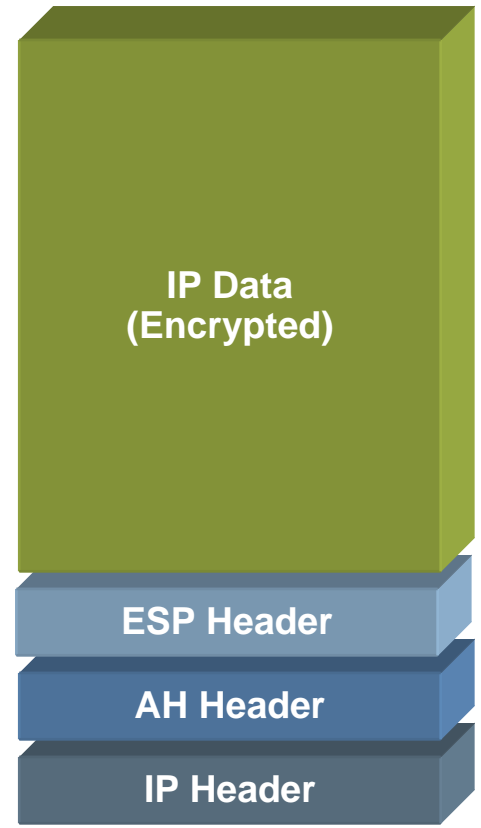



IPSec Framework

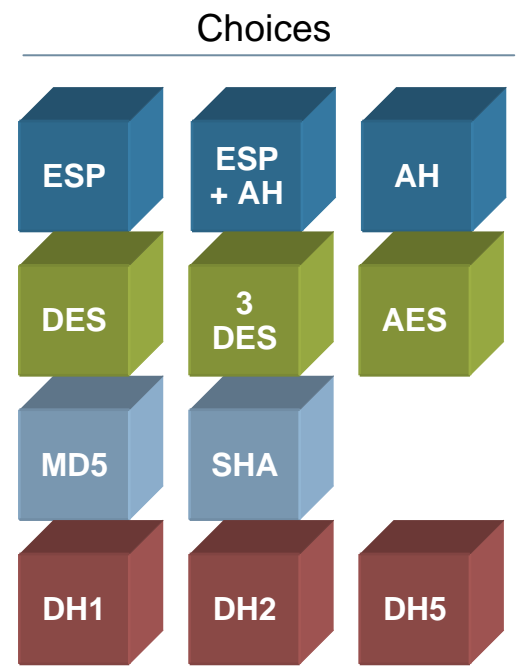
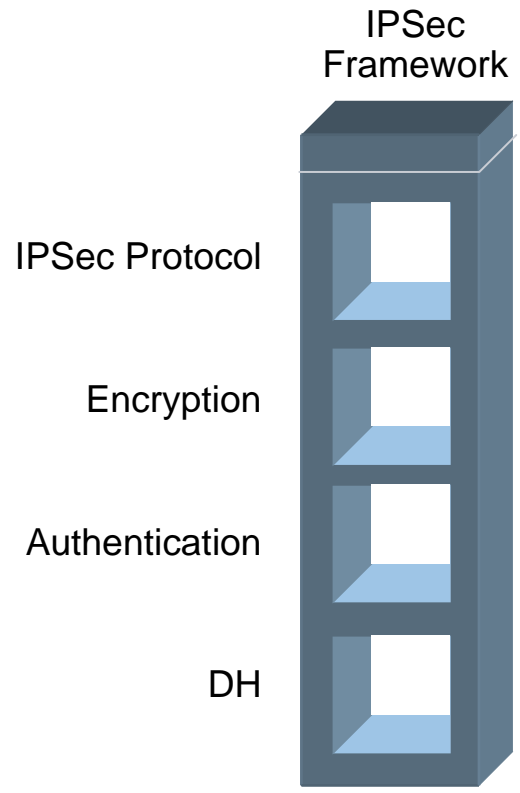

ESP—Encapsulating Security Payload

AH—Authentication Header

AES—Advanced Encryption Standard

MD5, SHA—Authentication

DH—Diffie-Hellman Identifier to Derive the Share Secret

Two Types of IPSec Security Protocols

Authentication Header



- Ensures data integrity
- Provides origin authentication—ensures packets definitely came from peer router
- Uses keyed-hash mechanism
- Does **not** provide confidentiality (no encryption)
- Provides optional replay protection

Encapsulating Security Payload



- Data confidentiality (encryption)
- Limited traffic flow confidentiality
- Data integrity
- Optional data origin authentication
- Anti-replay protection
- Does not protect IP header

IP Header with IPSec Information

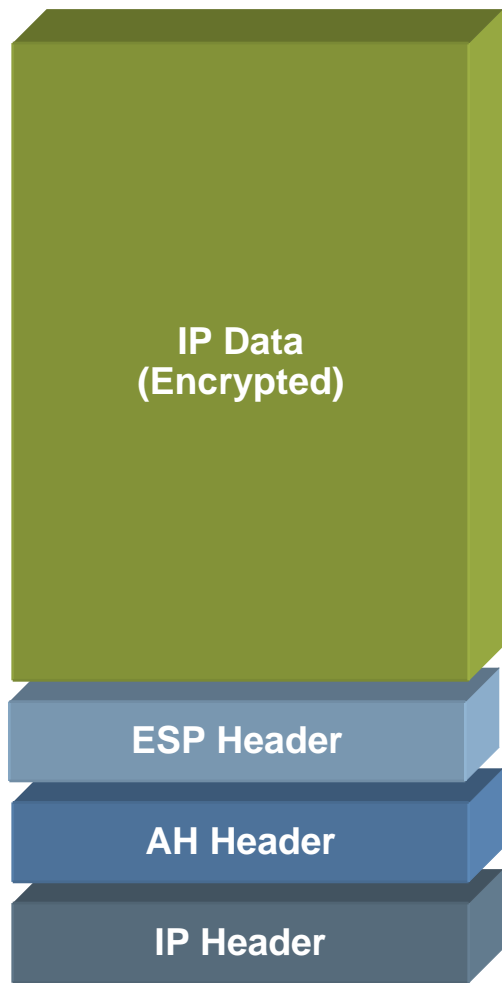

IPSec in a Standards World

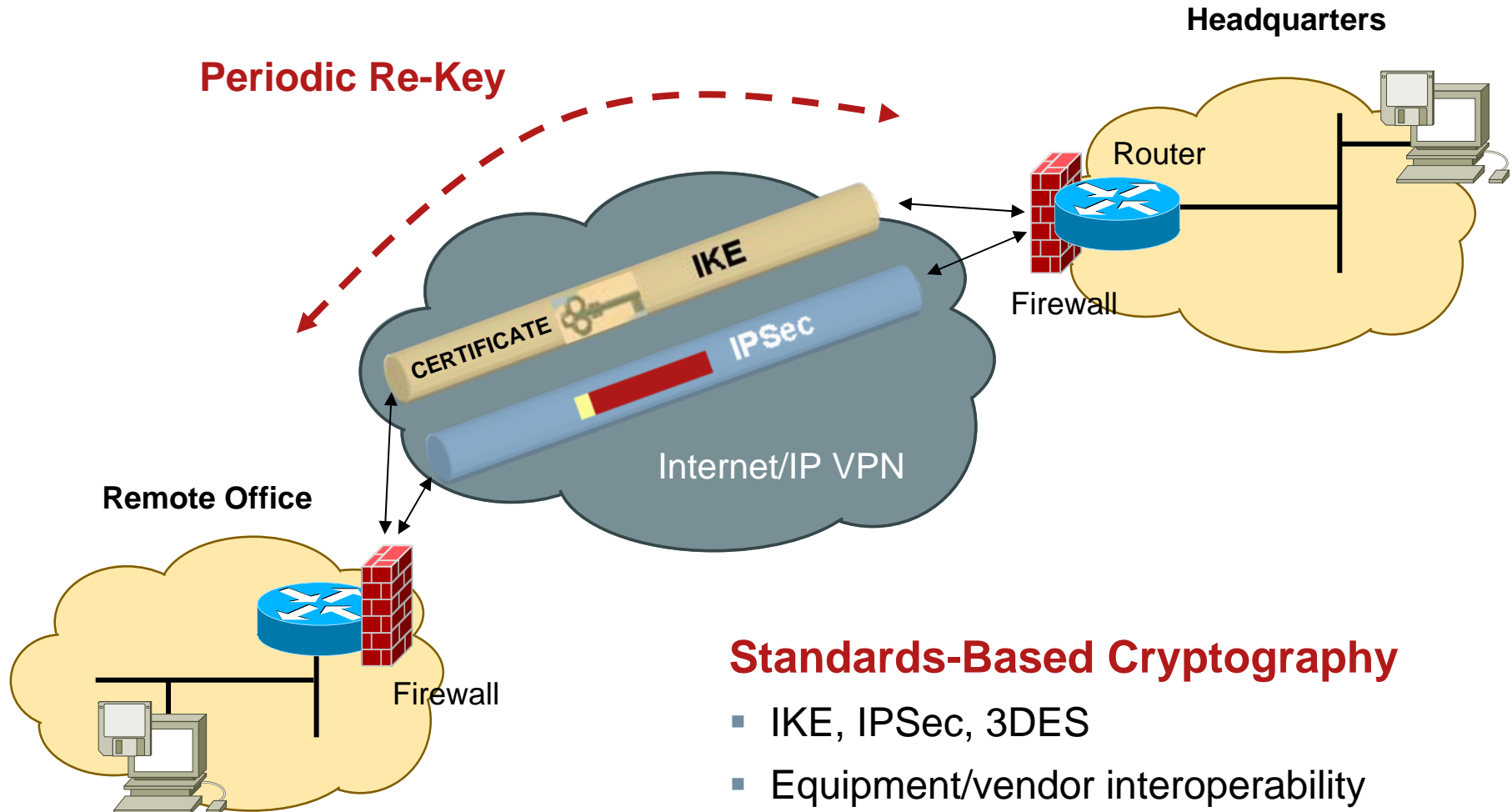

Standards-Based Cryptography

- IKE, IPSec, 3DES
- Equipment/vendor interoperability

IKE Benefits an IPsec Environment

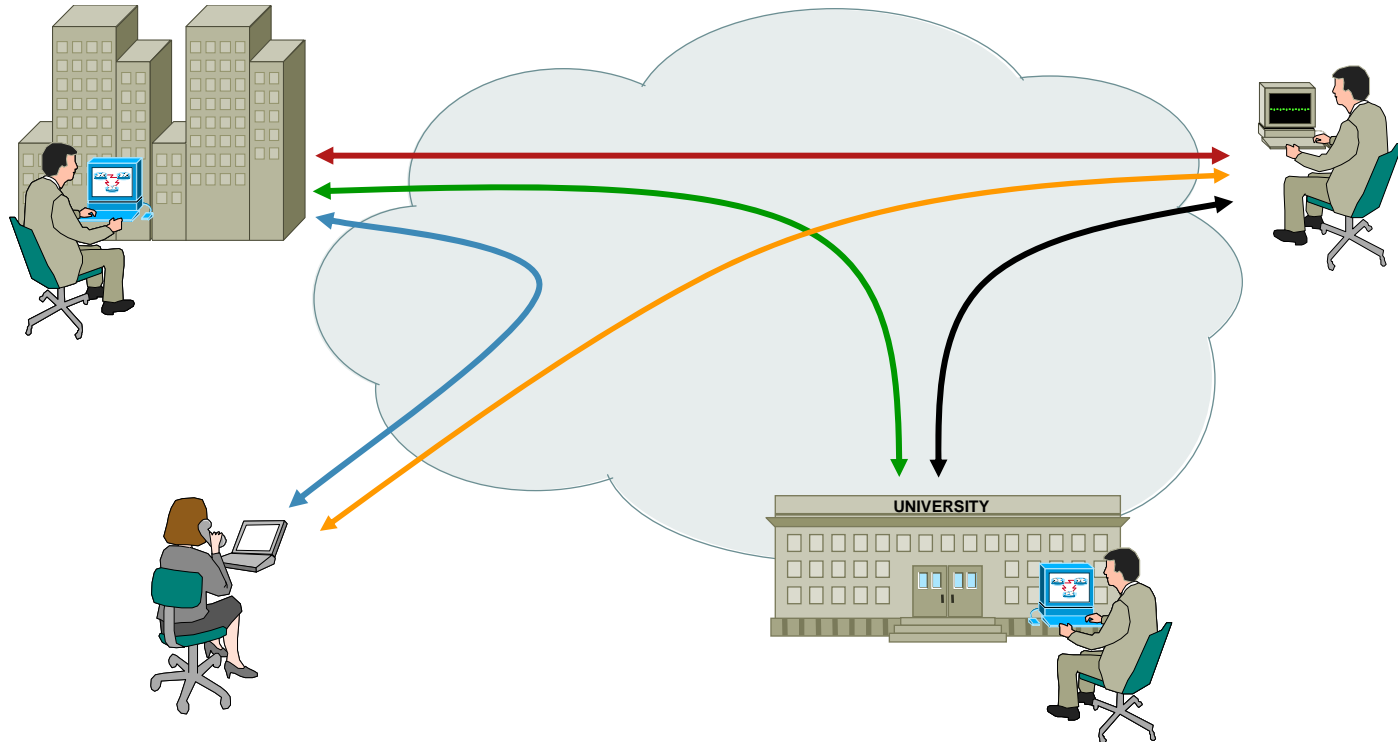

- Ensure confidential communications in an unsecured network
- Also known as the **Key Management Nightmare!!!**



IPSec: Building a Connection

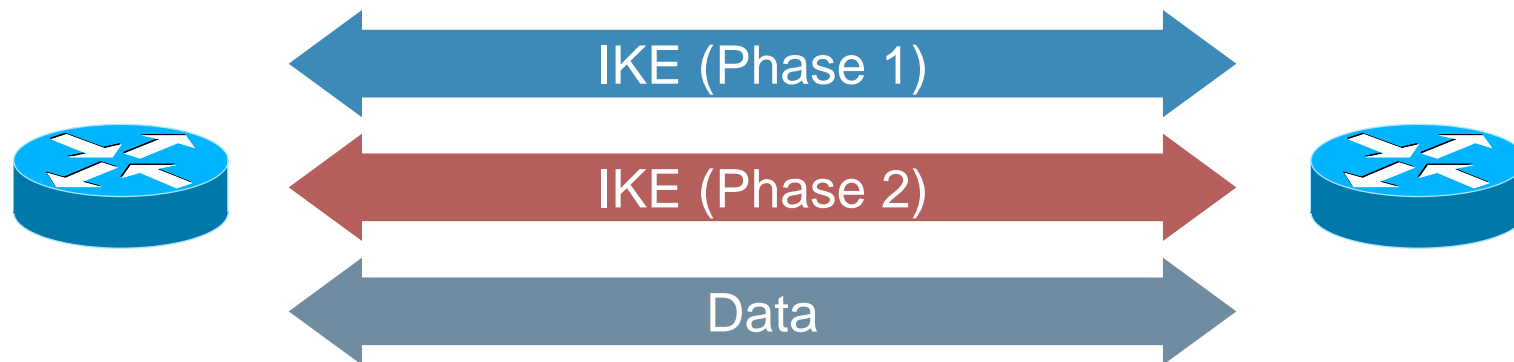

- Two-phase protocol:

- Phase 1 exchange:** two peers establish a secure, authenticated channel with which to communicate; **Main mode** or **Aggressive mode** accomplishes a Phase 1 exchange

- Phase 2 exchange:** security associations are negotiated on behalf of IPSec services; **Quick mode** accomplishes a Phase 2 exchange

- Each phase has its SAs: **ISAKMP SA** (Phase 1) and **IPSec SA** (Phase 2)



How Does IKE/IPSec Work?

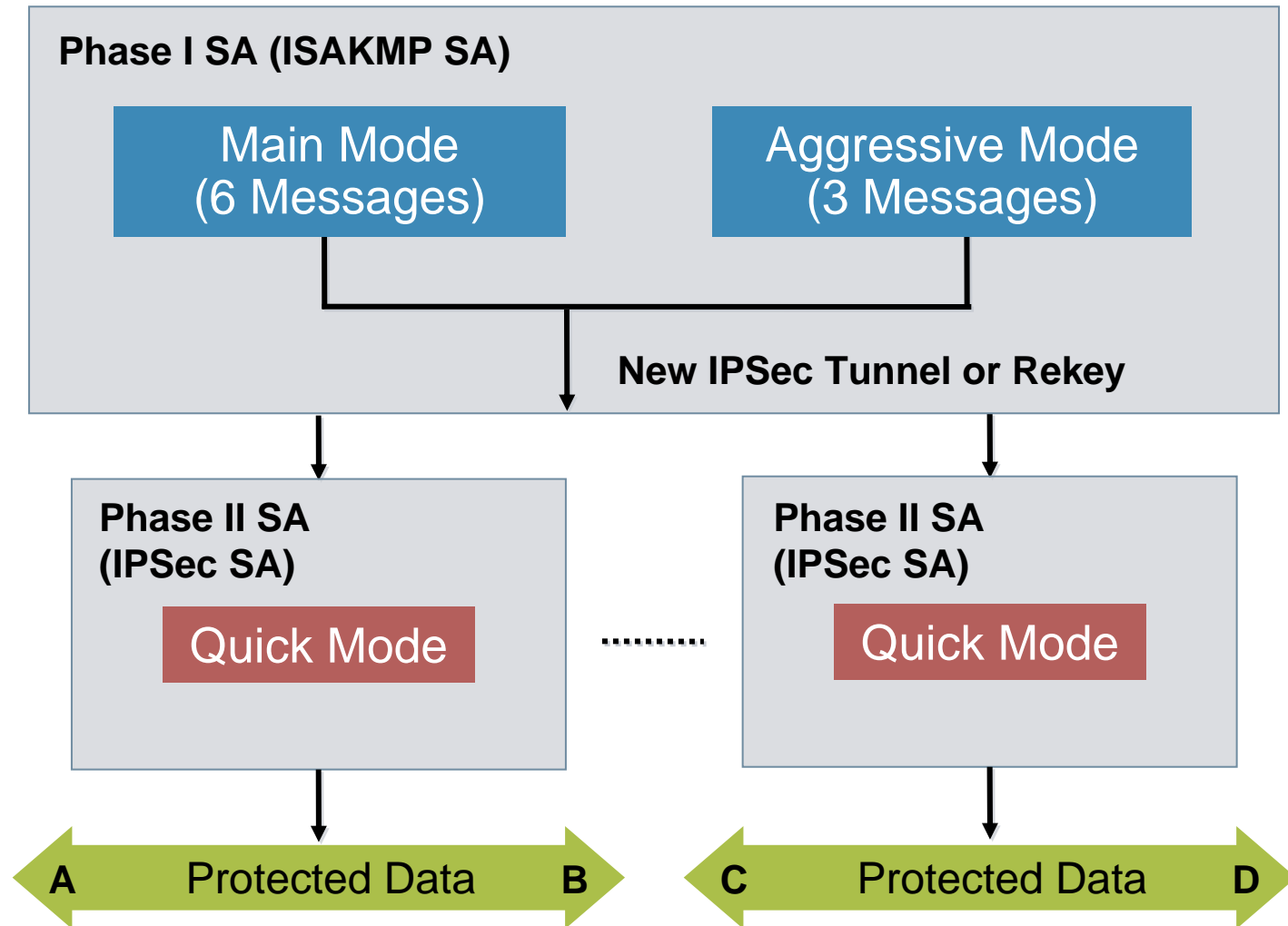



ISAKMP Main, Quick and Aggressive Modes

ISAKMP Main Mode (Phase 1)

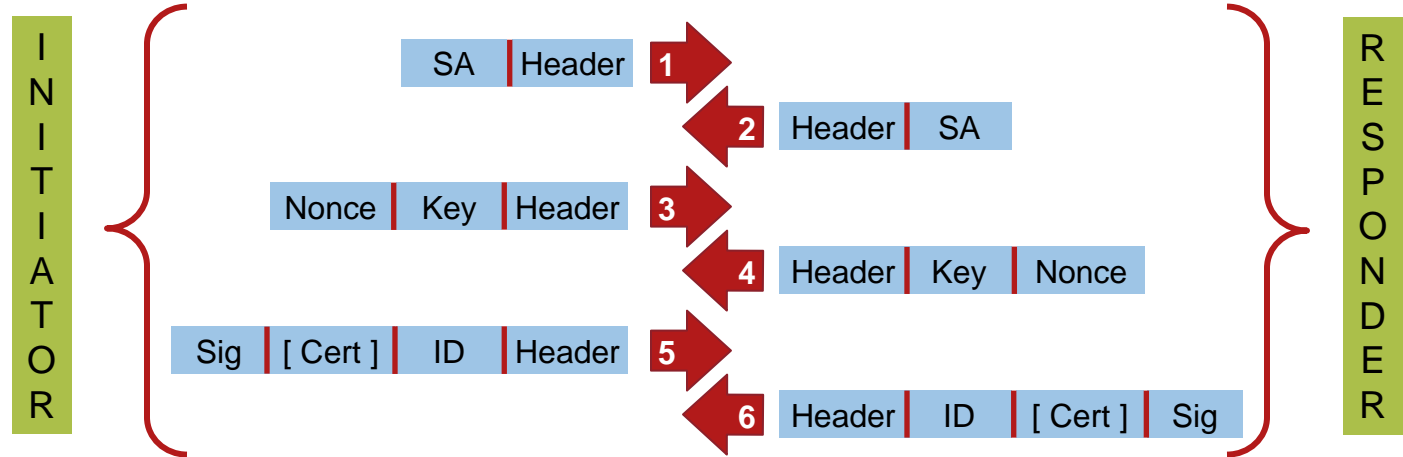

ISAKMP Quick Mode (Phase 2)

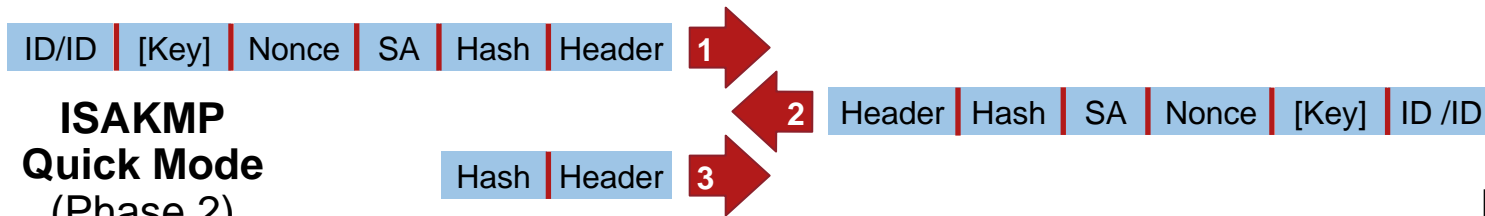

ISAKMP Aggressive Mode (Phase 1)

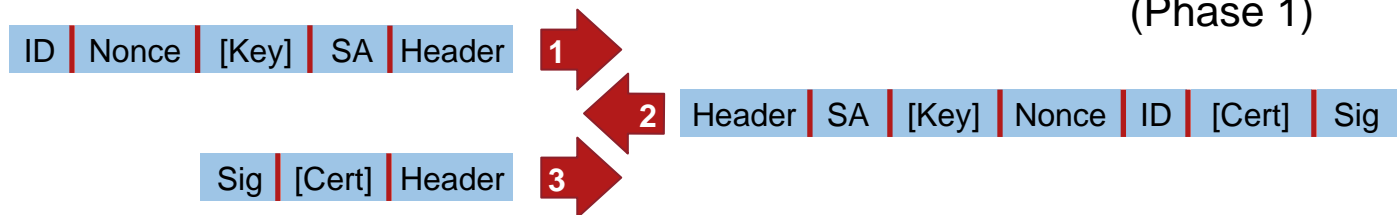

What Is a Web/SSL VPN?

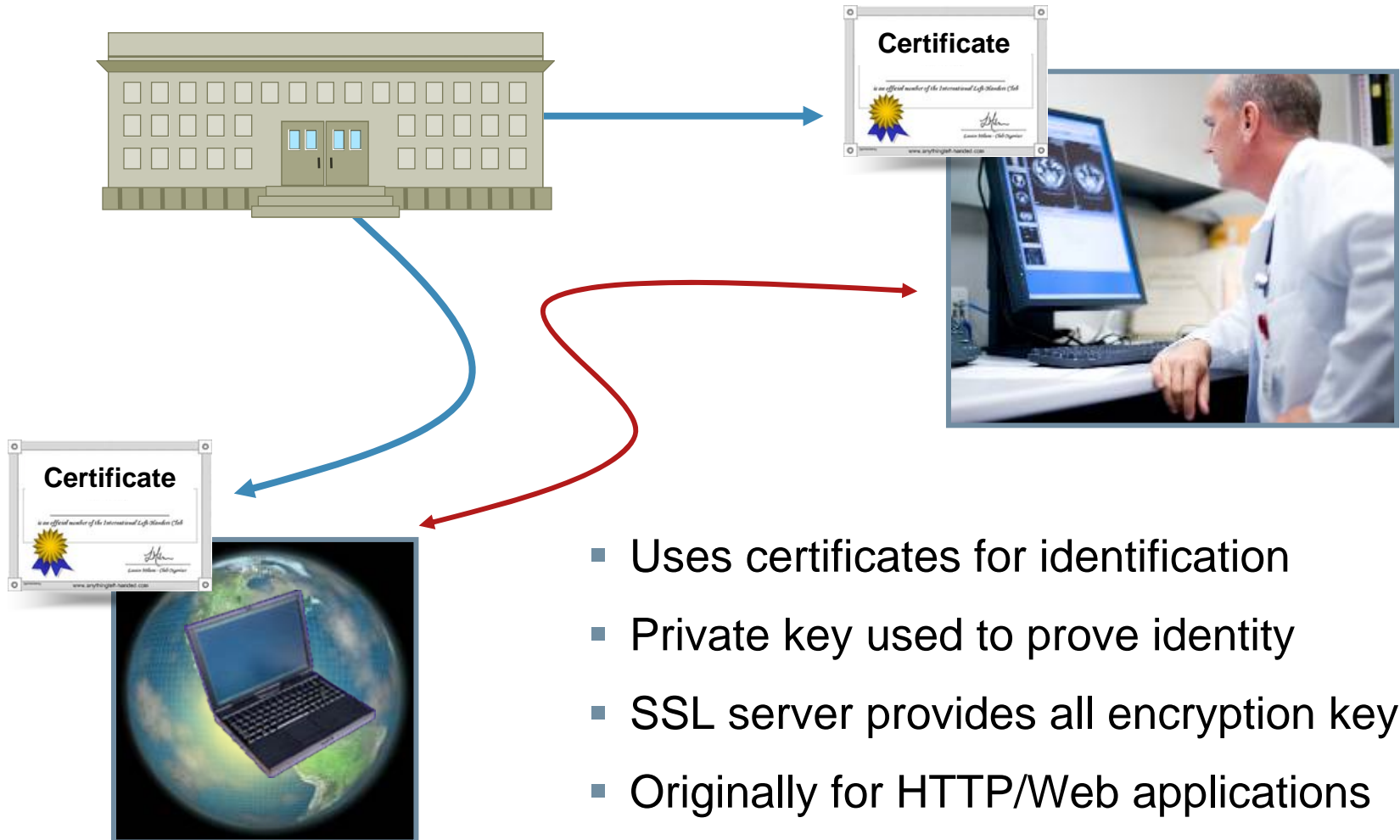

- Uses certificates for identification
- Private key used to prove identity
- SSL server provides all encryption keys
- Originally for HTTP/Web applications

Web/SSL VPN Features

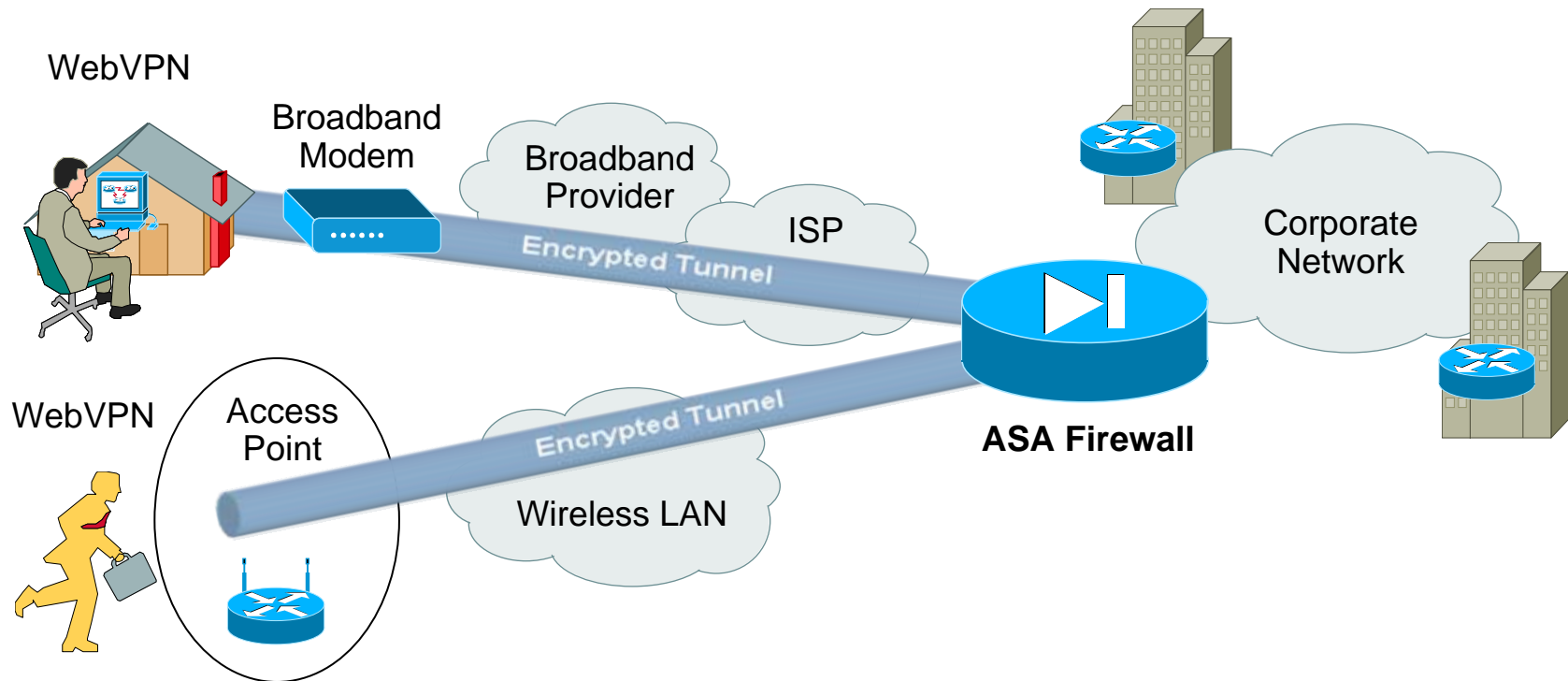

Feature

- Access to internal web sites (HTTP/HTTPS) including filtering
- Access to internal Windows (CIFS) File Shares
- TCP port forwarding for legacy application support
- Access to e-mail via POP, SMTP, and IMAP4 over SSL

Web/SSL VPN and IPSec Comparison

WebVPN

- Uses a standard web browser to access the corporate network
- SSL encryption native to browser provides transport security
- Application accessed through browser portal
- Limited client/server application accessed using applets

IPSEC VPN

- Uses purpose built client software for network access
- Client provides encryption and desktop security
- Client establishes seamless connection to network
- All application are accessible through their native interface

What Is a PPTP VPN?

Point to Point Tunneling Protocol

- PPTP is a network protocol used in the implementation of Virtual Private Networks (VPN); **RFC 2637** is the PPTP technical specification
- PPTP works on a client server model; PPTP clients are included by default in Microsoft Windows and also available for both Linux and Mac OS X; newer VPN technologies like L2TP and IPSec may replace PPTP someday, but PPTP/MPPE remains a popular network protocol especially on Windows computers

VPN Technology Options

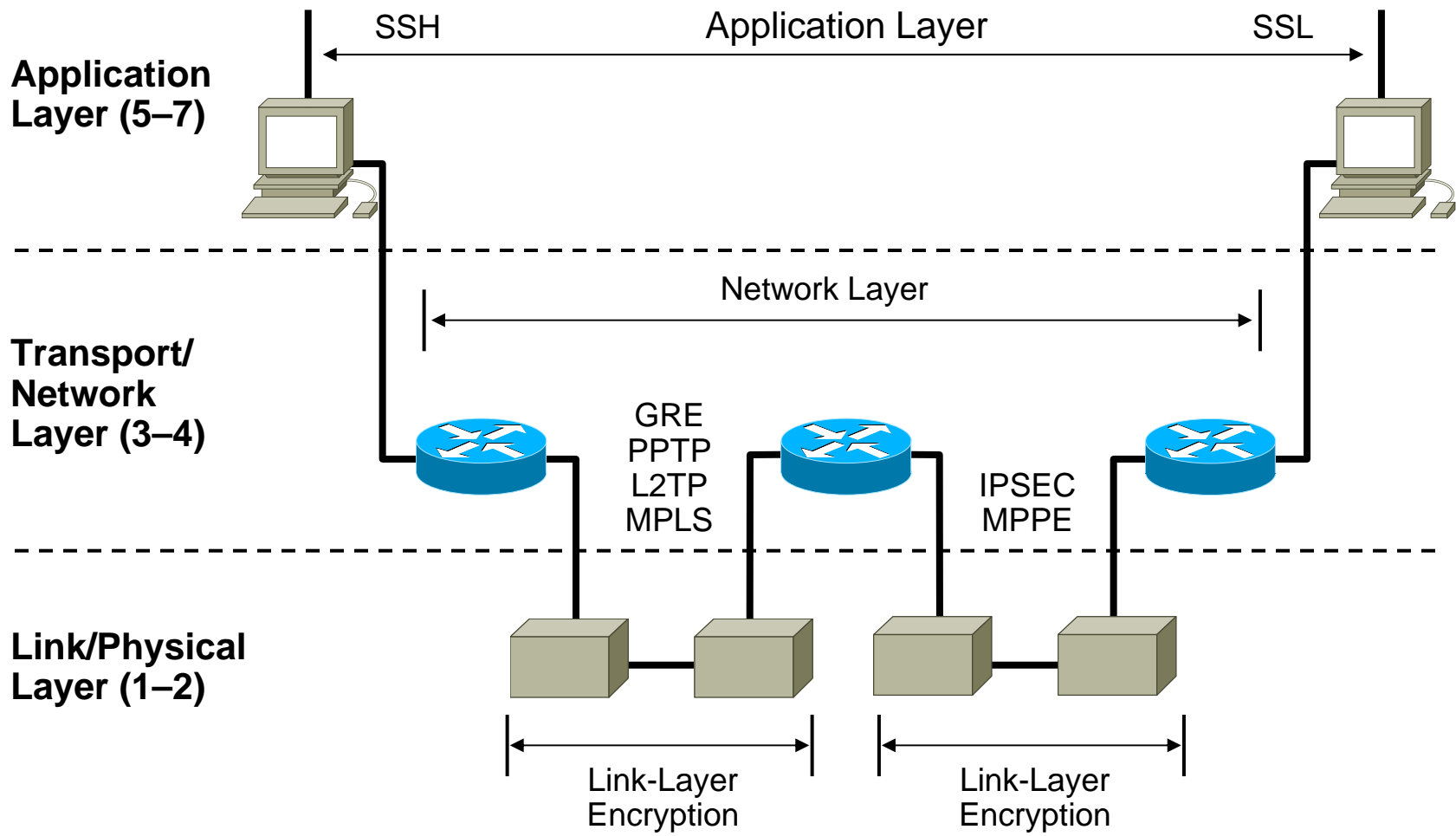

Benefits of PPTP

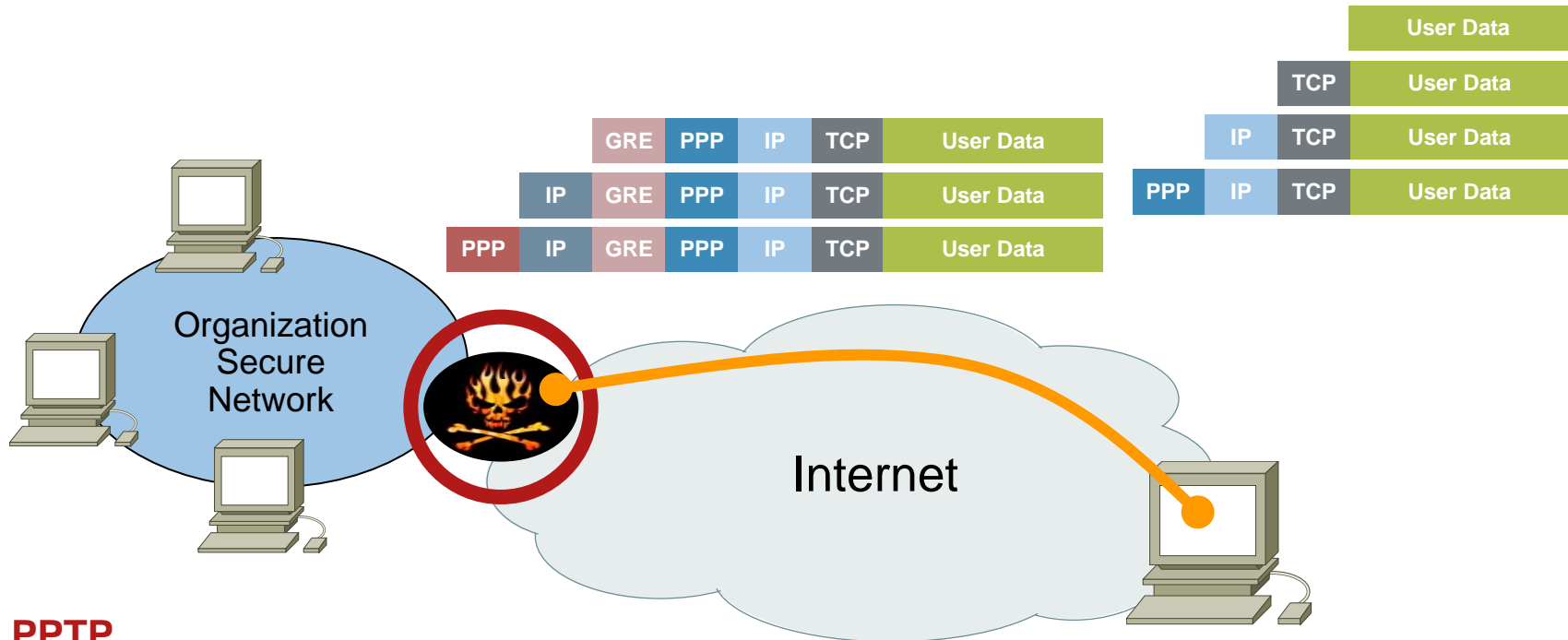

PPTP

- PPTP is point-point protocol over Ethernet
- Single tunnel between end-points: Single device support (GRE = generic routing encapsulation)
- Six bytes overhead when compression used
- No tunnel authentication
- With RADIUS server supports authentication and accounting
- CHAP V2 fixes password, masquerading, and encryption weakness
- 40 or 128 bit RC4 packet encryption

Is PPTP Secure? Yes

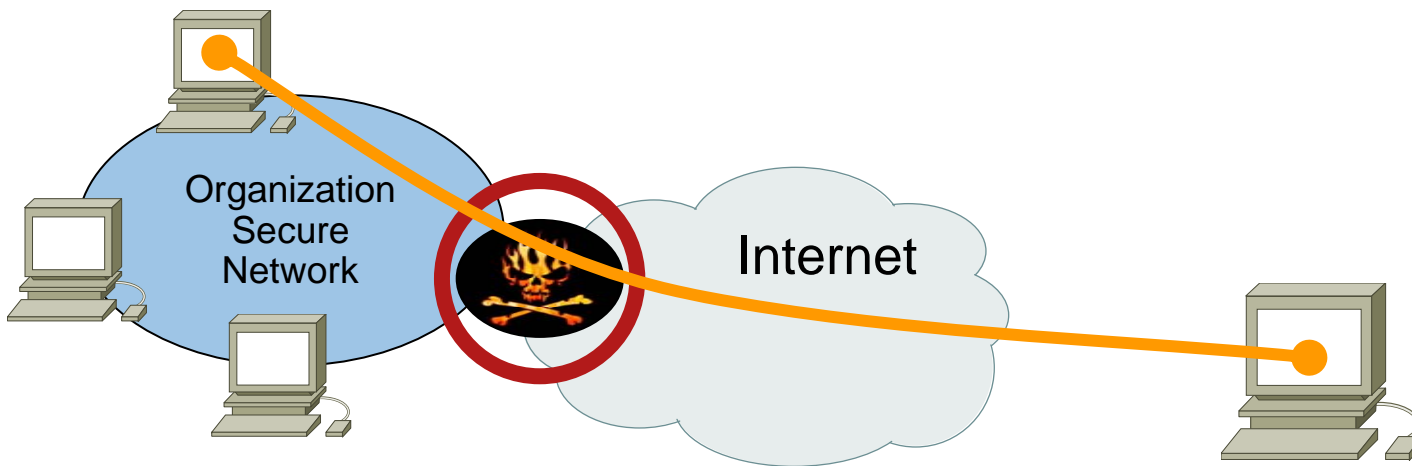

CHAP V2 Authentication with 40 or 128 bit RC4 Encryption

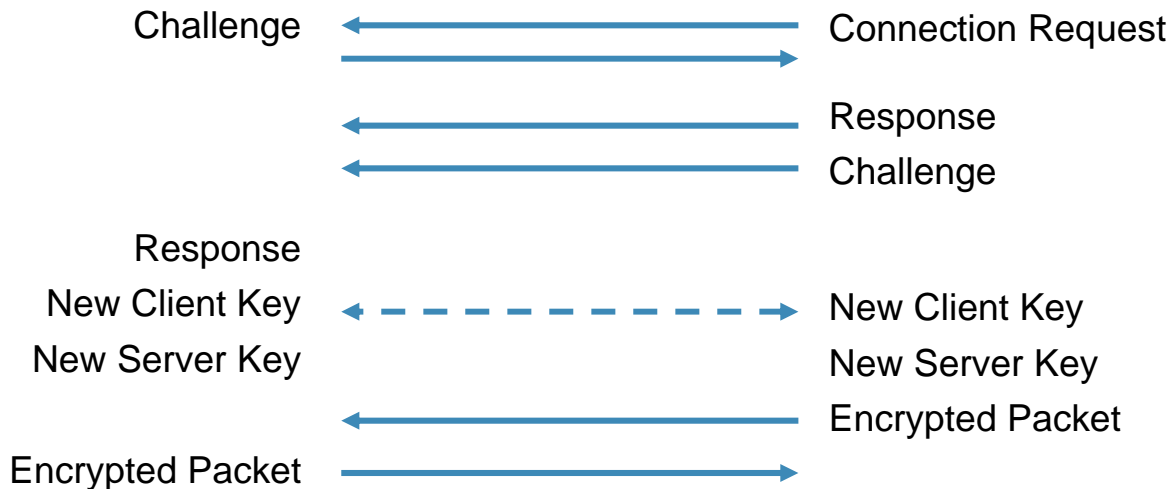

VPN Technology Comparison

	Simplicity Low Cost	Advanced Security
Application to Application	SSL	
End to End	IPSec Transport Mode	
Gateway to Gateway	PPTP	L2TP/IPSec IPSec Tunnel Mode
Client to Gateway	PPTP	L2TP/IPSec

PPTP—Point to Point Tunneling Protocol—Layer 2—Multiprotocol

L2TP/IPSec—Layer 2 Tunneling Protocol—Multiprotocol—Encryption and Authentication

IPSec—IP Security—Layer 3—IP Protocol—Encryption and Authentication

SSL—Secure Sockets Layer—Layer 6/7—Application—Encryption and Authentication

Group Exercise Configuring VPNs Lab



Summary

- Demonstration
- Introduction to VPNs
- VPN Security (IPSec, PPTP, SSL)
- VPN Technology Comparison
- VPN Group Exercise

Cisco | Networking Academy[®]

Mind Wide Open[™]



CISCO